

MONZA

Installation and Operating Instructions

安 装 使 用 说 明

Version 2022.1



Pole-top luminaires / 杆顶灯

Wall luminaires / 侧壁灯

9 31x 01 xx Monza

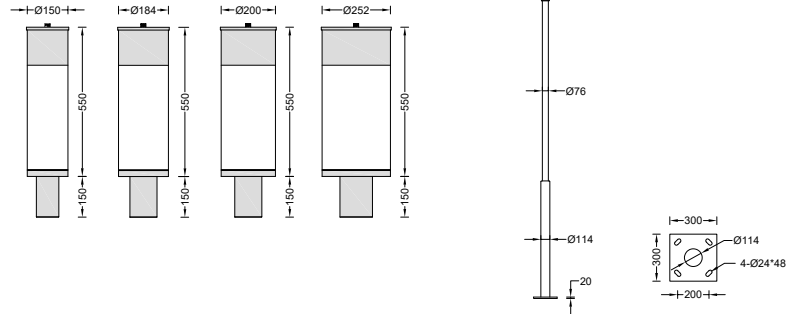

Important Information / 重要信息

1. The installation and maintenance of the product can only use the original parts, and the installation and operation of the equipment shall be subject to national and international regulations.
本产品安装和维护工作只能使用原厂配件，设备的安装和操作适用于国家和国际法规。
2. DMK is not liable for any damages resulting from improper or unskilled conduct.
DMK 不承担任何因不当或不熟练行为而造成的损害赔偿。
3. Only qualified installation personnel are allowed to assemble and install products obtained from the DMK.
只允许有安装资质的人员组装和安装从 DMK 获得的产品。
4. The contents of this manual are subject to change without prior notice. Please refer to the material in kind.
本说明书的内容如有变更，恕不另行通知。请以实物为准。
5. If in doubt, please contact the supplier.
如有疑问，请与供应商联系。

Toolings / 工具

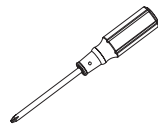

十字螺丝刀



4mm 内六角扳手



30mm 开口扳手

Recommended Installation Procedure / 推荐安装过程

1. Fix the fixture on the embedded part with M20 nut and Ø20mm flat pad.
用 (M20 螺母、Ø 20 平垫) 将灯杆固定在预埋件上。



Keep the pole perpendicular to the ground.
使灯杆与地面保持垂直。

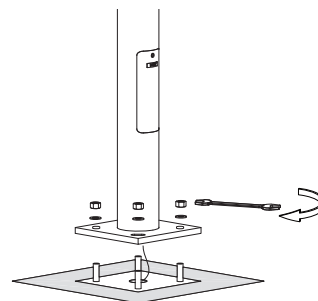

Recommended Installation Procedure / 推荐安装过程

- connect the plug terminal of the power cord, put the fixture on the pole and rotate it to the appropriate position. Tighten 6-M8 screw with 4mm inner hexagon wrench.
将灯头插入灯杆，电源线对插端子连接，旋转至合适的位置，用4mm 内六角扳手拧紧下方 6-M8 紧定螺钉固定灯头。



Make sure the "house" tag faces the building!
确保“房子”标签定位正确!

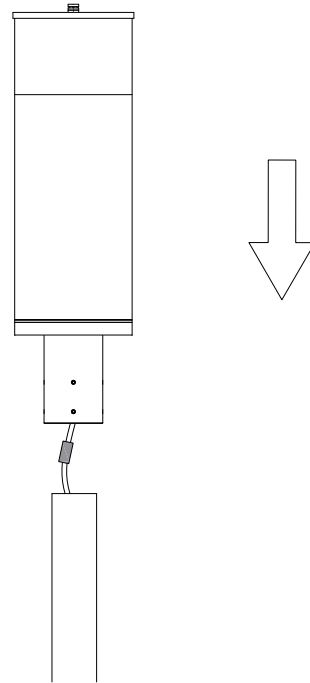

- Open the access door with the triangle key and connect the 220V power supply.
用三角钥匙打开灯具检修门，连接 220V 电源。



This step should be operated by professional personnel to avoid electric shock.
此步骤需由专业人员操作，以免发生触电危险。

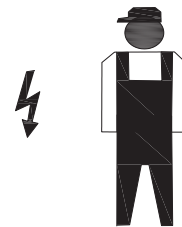
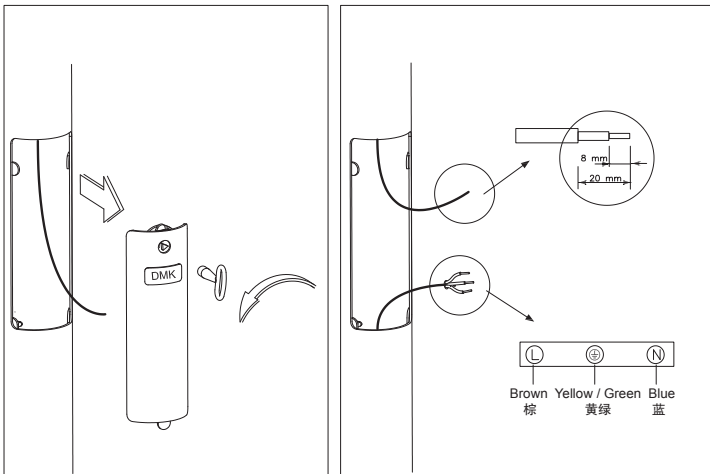

9 31x 01 xx Monza

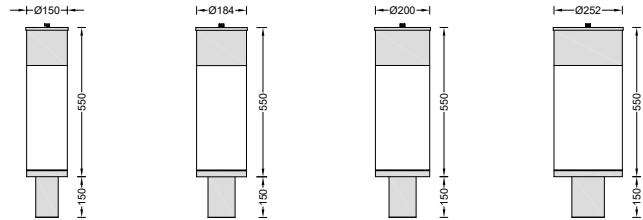

Important Information / 重要信息

1. The installation and maintenance of the product can only use the original parts, and the installation and operation of the equipment shall be subject to national and international regulations.
本产品安装和维护工作只能使用原厂配件，设备的安装和操作适用于国家和国际法规。
2. DMK is not liable for any damages resulting from improper or unskilled conduct.
DMK 不承担任何因不当或不熟练行为而造成的损害赔偿。
3. Only qualified installation personnel are allowed to assemble and install products obtained from the DMK.
只允许有安装资质的人员组装和安装从 DMK 获得的产品。
4. The contents of this manual are subject to change without prior notice. Please refer to the material in kind.
本说明书的内容如有变更，恕不另行通知。请以实物为准。
5. If in doubt, please contact the supplier.
如有疑问，请与供应商联系。

Toolings / 工具

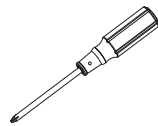

十字螺丝刀



4mm 内六角扳手



10mm 开口扳手

Recommended Installation Procedure / 推荐安装过程

1. Open the fixing hole as shown.
按图示开固定孔。

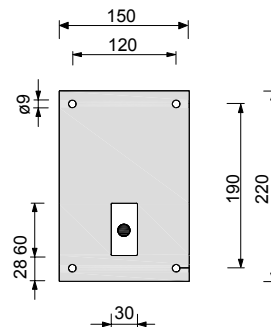

Recommended Installation Procedure / 推荐安装过程

- Fix the mounting bracket to the wall with M6 expansion screws.
用 M6 膨胀螺丝将安装支架固定到墙壁上。

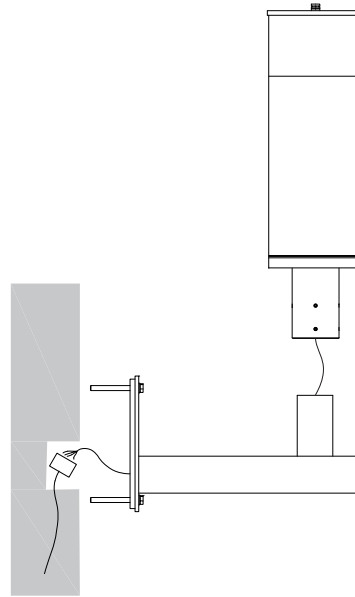

- Connect the 220V power supply.
连接 220V 电源。



This step should be operated by professional personnel to avoid electric shock.
此步骤需由专业人员操作，以免发生触电危险。

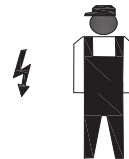
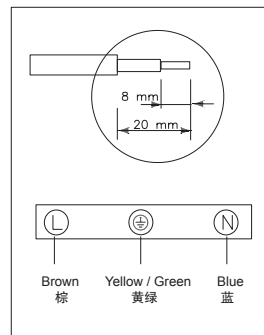

- Fix the fixture to the mounting bracket with 6-M8 screw.
将灯具用 6-M8 螺丝固定到安装支架上。

